

Article number: 588N2B112ST0457

Description: Solenoid valve type N2B112.ST0.457 2/2 NC
230 VAC 50HZ orifice 1,2 housing in Stainless AISI 303 Inlet port G1/8"

Measures

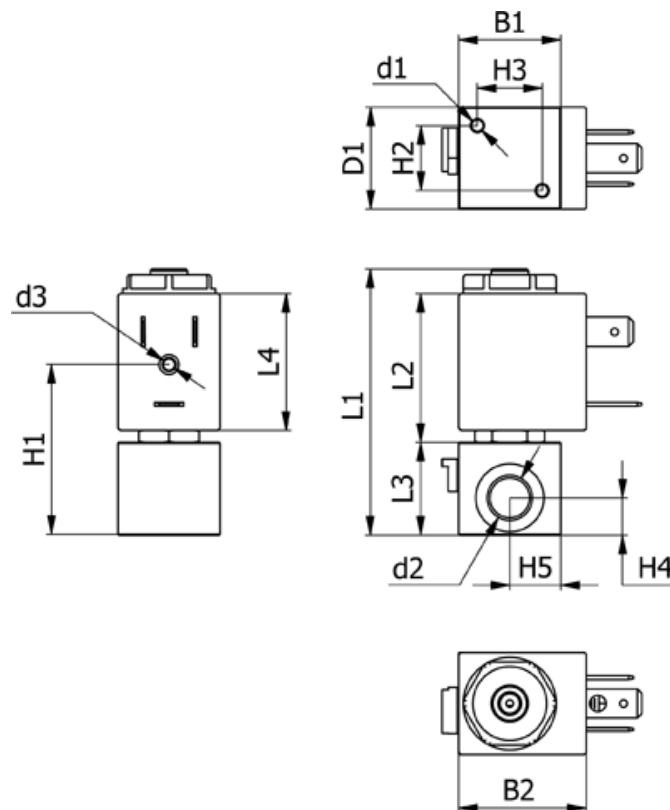

B1 = 22	H2 = 14	Orifice = 1.2
B2 = 31.1	H3 = 14	Valve function = 2/2 NC
d1 = M3x6	H4 = 8	Voltage = 230 VAC 50HZ
D1 = 22	H5 = 11	
d2 = G1/8"	L1 = 56.2	
d3 = M3x4	L2 = 32.1	
Flow = 0.5	L3 = 20	
H1 = 36.6	L4 = 29.5	